

B (Flap position detector)

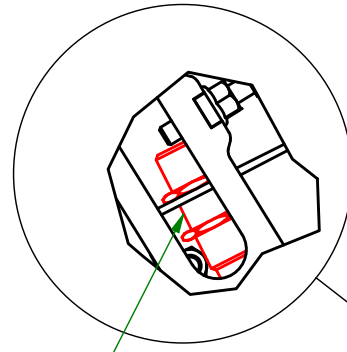

Inductive detector M18

C (Build up detector)

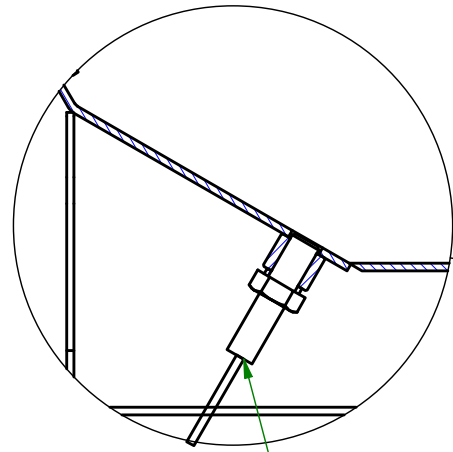

Capacitive detector M12

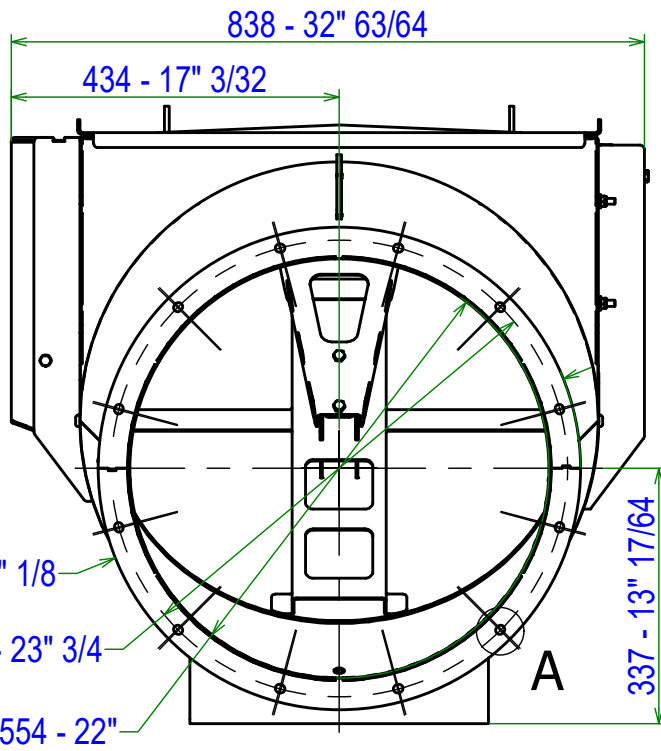
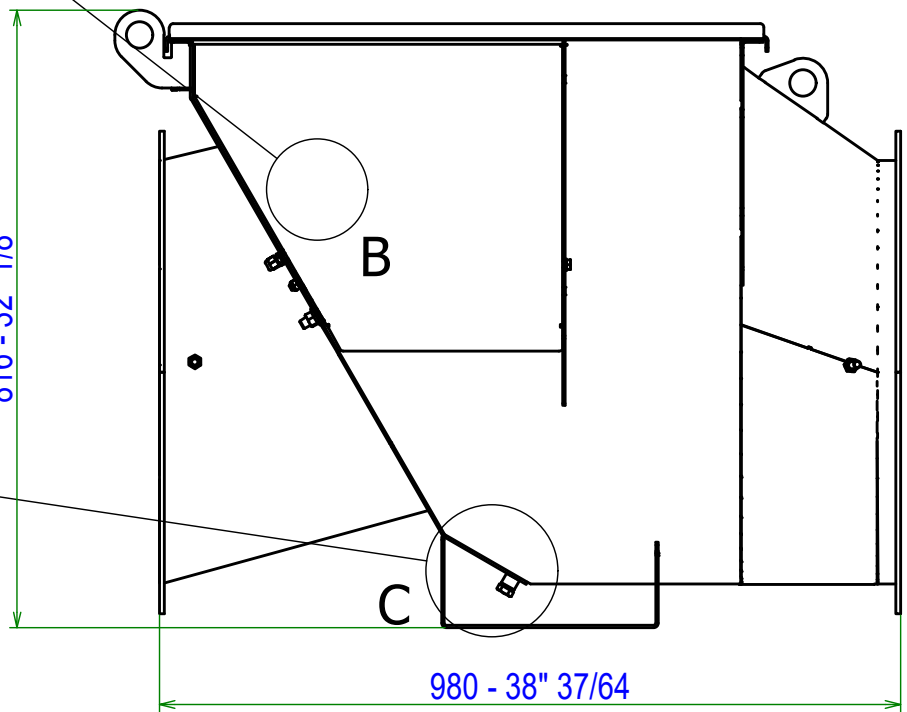

A (Hole x12 for 3/8 screw)

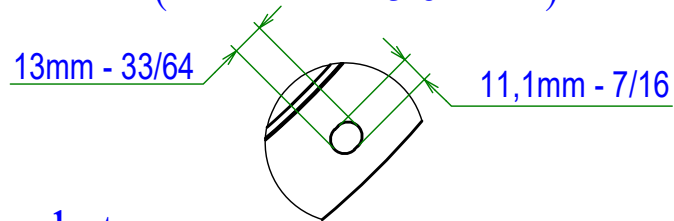

Pressure resistance = 2bar
Optional flanges and flange gaskets

Informative dimension

Weight : 83 kg

A	Création	22/03/21	BM	MJ
Ind.	Objet de la modification	Date	Nom	Vérif.
Matière:		Date de création: 04/11/2020	A3	Ech.: s/e
Plan n°: 57VP_022_Clt				
Désignation: VigiFlap PASSIVE Ø22"				